



Sink - Tara.

Single-hole lavatory mixer with drain - polished chrome

Article number: 22 512 892-00 0010



- 5-3/8" Projection
- US drain with overflow
- Swiveling spout 360°
- Round aerated stream
- Total height 10-7/8"
- Height to aerator/spout outlet 6-5/8"
- 1-3/8" hole diameter
- Flange diameter 2-3/8"
- 2x 3/8" US flexible supply lines
- Water flow rate limited to max. 1.2 gpm
- lead-free
- (ADA)
- Suitable only for basins with overflow.



polished chrome





Sink - Tara.
Single-hole lavatory mixer with drain - polished chrome
Article number: 22 512 892-00 0010

Dimensional drawing

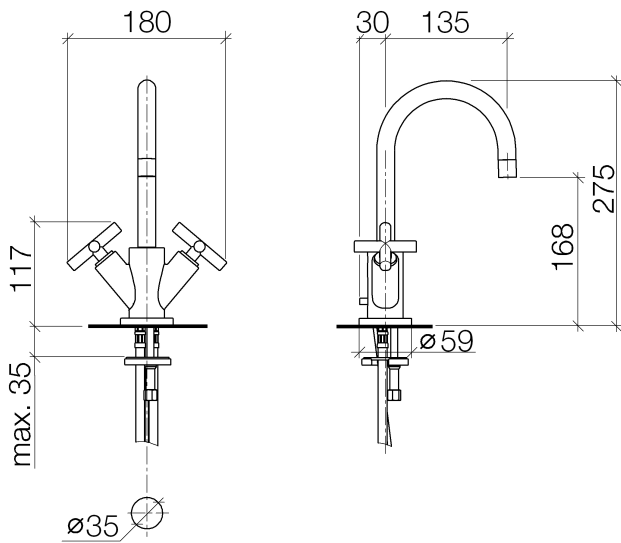

All dimensions in mm / inch = mm x 0,0394

Flow rate chart

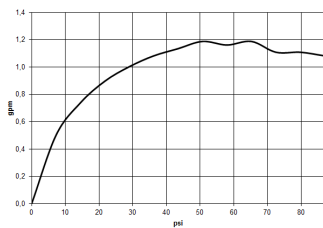



Sink - Tara.

Single-hole lavatory mixer with drain - polished chrome

Article number: 22 512 892-00 0010

Other surface finishes



platinum matte

22 512 892-06 0010



platinum

22 512 892-08 0010



Brushed Durabronze

22 512 892-28 0010



black matte

22 512 892-33 0010



Dark Platinum matte

22 512 892-99 0010

More custom finish options are available via special production (xTra Service). Please see our finish matrix for availability and pricing or contact a Dornbracht representative.

Sink - Tara.

Single-hole lavatory mixer with drain - polished chrome

Article number: 22 512 892-00 0010

Spare parts list

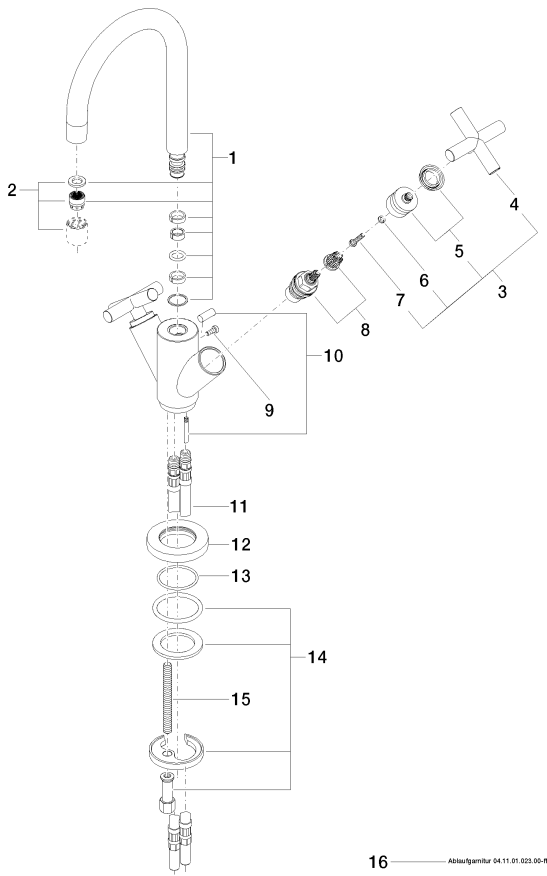

Number	Item Number	Designation	Number of units
1	90 28 22 217 02-00	spout	1
2	90 23 01 028 04-00	aerator	1
3	04 20 89 010 00-00	handle	2
4	09 20 89 010-00	handle	2
5	90 12 12 007 00-00	base	2
6	09 30 11 029 90	disc	2
7	09 30 30 075 90	screw	2
8	90 90 03 151 00 90	top	2
9	09 30 30 054 90	screw	1
10	04 20 89 035 80-00	pull-rod	1
11	04 30 04 045 00 90	Flexible supply line 3/8"	2
12	09 28 10 132-00	ring	1
13	09 14 10 134 90	seal	1
14	04 30 11 038 00 90	fixing set	1
15	09 31 11 011 90	pin	1
16	04 11 01 023 00-00	Drain - polished chrome	1