

Ketho

KT 6650

Installation instructions

A mm	A inch	B mm	B inch
600	23 5/8"	376	14 3/4"

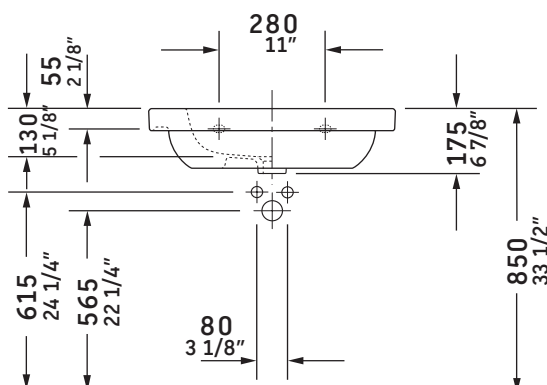
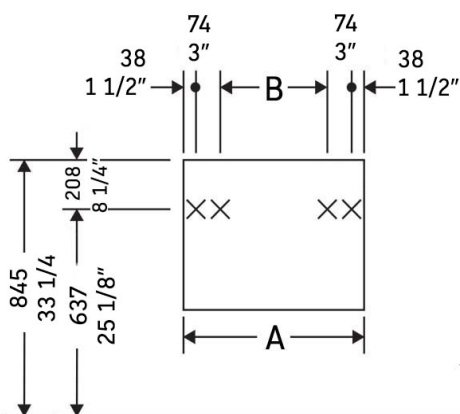

034265

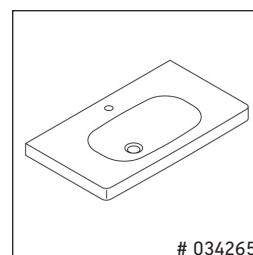
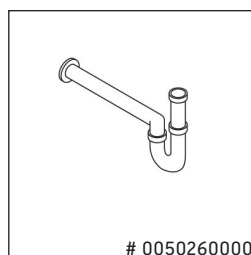
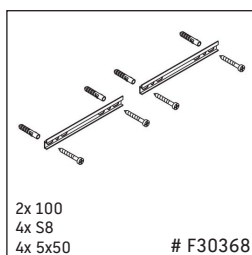
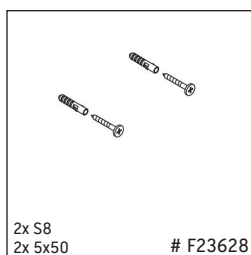
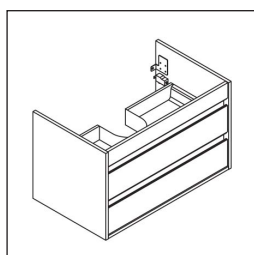

Instructions for use

The bathroom furniture range complies with the standards and guidelines applicable at the time of delivery and is designed for use in bathrooms. Though designed for the wet environment, direct contact with water should be avoided, for example, when showering. We reserve the right to make technical improvements and design modifications to the products illustrated.

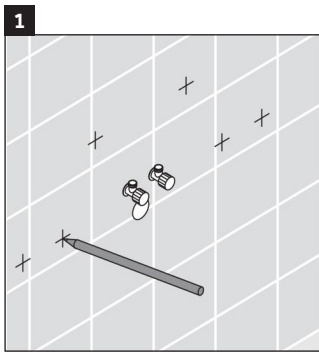

Reference the washbasin specification to establish the position of mounting bolts, mark the holes to be drilled for the anchors.

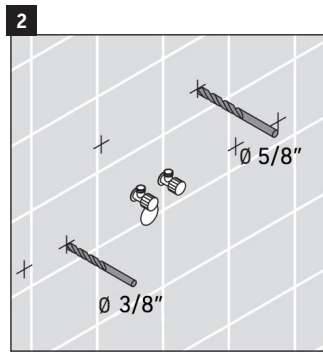

Using a 3/8" and 5/8" drill bit, drill the anchor holes that have been marked.

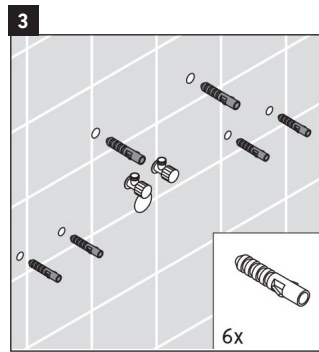

The plastic anchors provided are for concrete wall applications.

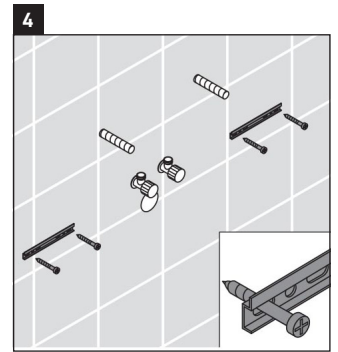

For wood stud walls, bolts should be screwed into wood backing.

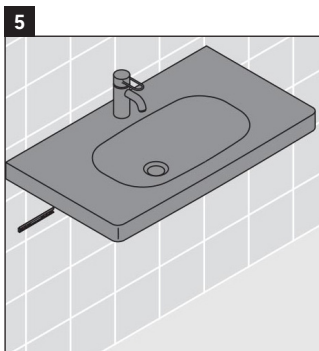

When mounting the washbasin into a wood stud wall, there must be adequate bracing. We recommend doubling up 2 x 6's or 2 x 8's between the studs to form a solid anchoring point. Screw mounting bolts into the pre drilled holes with an adjustable wrench. Screw in the full length of the mounting bolt, so that the lag thread is no longer visible. Carefully slide washbasin onto the mounting bolts. Insert the white plastic sleeve over bolt and into the hole in the washbasin. Install provided washer and nut. Hand tighten the nut, so the washbasin is secure. Install the siphon.

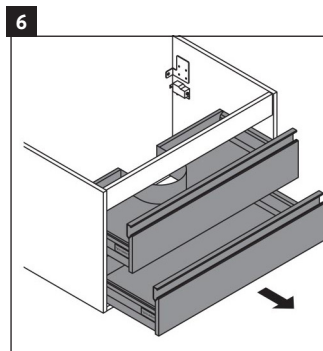

Remove the vanity drawer.

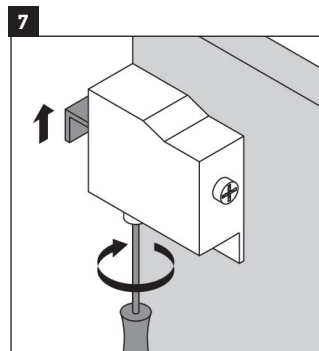

Using a screwdriver, adjust the vanity mounting hinge system clockwise.

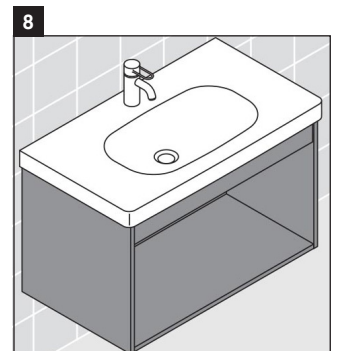

Slide the vanity under the washbasin. Tighten mounting bolts with a wrench until the washbasin is stable.

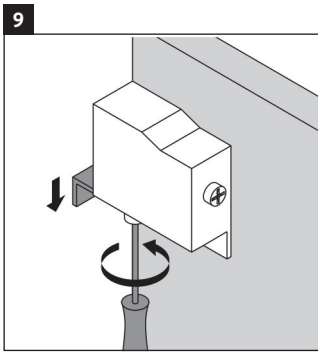

Using a screwdriver adjust the vanity mounting hinge system counter-clockwise.



Check the leveling of vanity for adjustment.

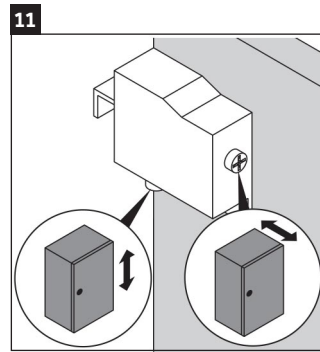

Screw two set screws until desired leveling of the vanity has been reached.

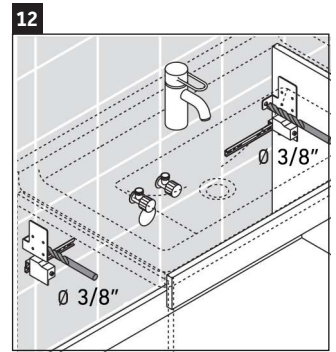

Using the appropriate bit for the wall material, drill pilot holes.

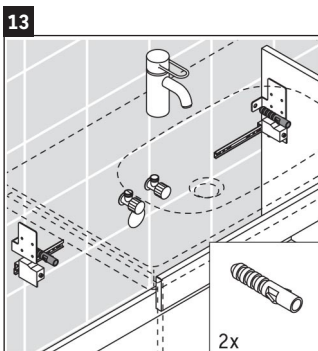

The plastic anchors provided are for concrete wall applications.

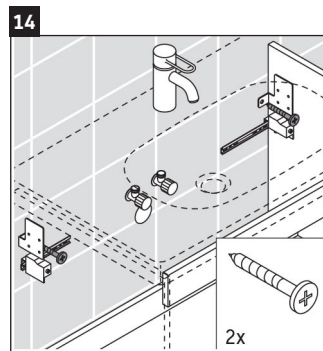

For wood stud walls, bolts should be screwed into wood backing.



Install the faucet and siphon.



Install the vanity drawer.

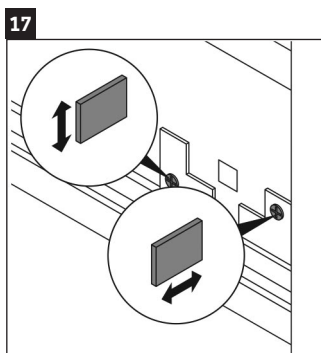

Remove plate with Duravit logo.

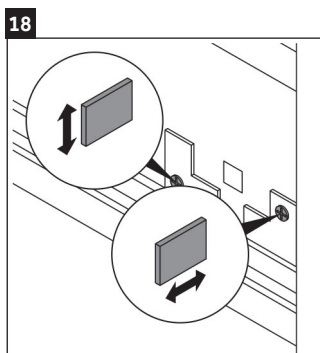

Level the vanity drawer by adjusting the two screws.

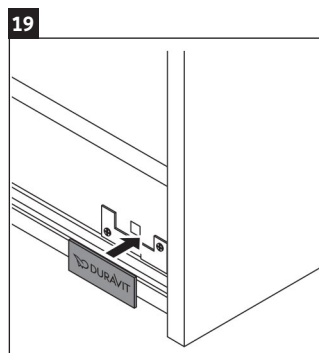

Re-attach plate with Duravit logo.



Apply silicone bead between washbasin and the wall.

Furniture complies with applicable requirements of the referenced standard(s):
Safety Household and Commercial Furnishings (UL 962, 3rd ed. Issued: 07/07/08, Revised: 08/05/13)
Portable Luminaires CSA C22.2 No. 12 - 1982 (R2004)

IMPORTANT SAFETY INSTRUCTIONS

When using an electrical furnishing, basic precautions should always be followed, including the following:

Read all instructions before using this furnishing.

DANGER To reduce the risk of electric shock:

1. Always power down all circuits before cleaning.

WARNING To reduce the risk of burns, fire, electric shock, or injury to persons:

1. Disconnect from power before putting on or taking off parts. A minimum of two people is required to remove and replace cabinet doors.
2. Close supervision is necessary when this furnishing is used by, or near children, invalids, or disabled persons.
3. Use this furnishing only for its intended use as described in these instructions. Do not use attachments not recommended by the manufacture.
4. Never operate this furnishing if it has a damaged cord or plug, if it is not working properly, if it has been dropped or damaged, or dropped into water. Return the furnishing to a service center for examination and repair.
5. Never drop or insert any object into any opening.
6. Do not use outdoors.
7. Do not operate where aerosol (spray) products are being used or where oxygen is being administered.
8. For loading always put heavier items at the bottom and not near the top in order to help prevent the possibility of the furnishing tipping over.
MAXIMUM SHELF LOAD IN POUNDS ALLOWED: 6.61 lbs
9. To disconnect, power down all circuits.
10. Risk of Injury to Persons - do not place video equipment such as televisions or computer monitors on furnishing.

GROUNDING INSTRUCTIONS

This product must be connected to a grounded metal, permanent wiring system, or an equipment - grounding conductor must be run with the circuit conductors and connected to the equipment grounding terminal or lead on the product.

ABOUT THE PRODUCT

Products requiring electricity are designed to be switched at the wall and hardwired to a circuit provided by the customer. Product should be installed according to electrical code by a qualified technician. Read important safety instructions carefully. Direct wetting should be avoided. This products is intended for household/residential use only. We reserve the right to make technical improvements and to enhance the appearance of the products shown.

SAVE THESE INSTRUCTIONS

Duravit NYC

105 Madison Avenue
New York, NY 10016
Toll Free 888-DURAVIT
Phone 212-686-0033
Fax 212-686-8033
info@us.duravit.com
www.duravit.nyc

Duravit USA, Inc.

2635 North Berkeley Lake Rd., Ste. 100
Duluth, GA 30096
Toll Free 888-DURAVIT
Phone 770-931-3575
Fax 770-931-8454
info@us.duravit.com
www.duravit.us

