

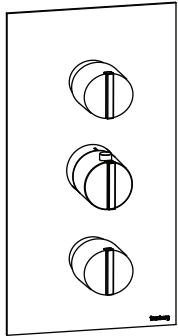

**145.4401 | 3/4" Thermostatic Valve With 2 Independent Volume Controls**

**SPECIFICATIONS:**



Trim  
[ 145.4500T\*\* ]

+

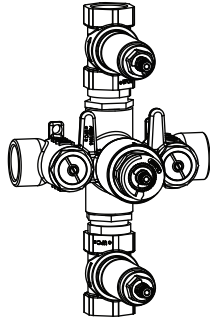

Valve  
[ TVH.4401 ]

- Turn middle knob to control temperature.
- Turn top knob to control water flow from top output.
- Turn bottom to control water flow from bottom output.
- Thermostatic Valve Flow Rate - 13.0 GPM @ 60 PSI
- Both outputs can be activated at once.
- Extension Available - TVH.4401E\*\*

Belgian Mirror Finish



Legislation Compliance



ZeroDrip Technology



See Spec Sheet For  
TVH.4401 For Detailed  
Information On Valve.

**Technical Diagram**

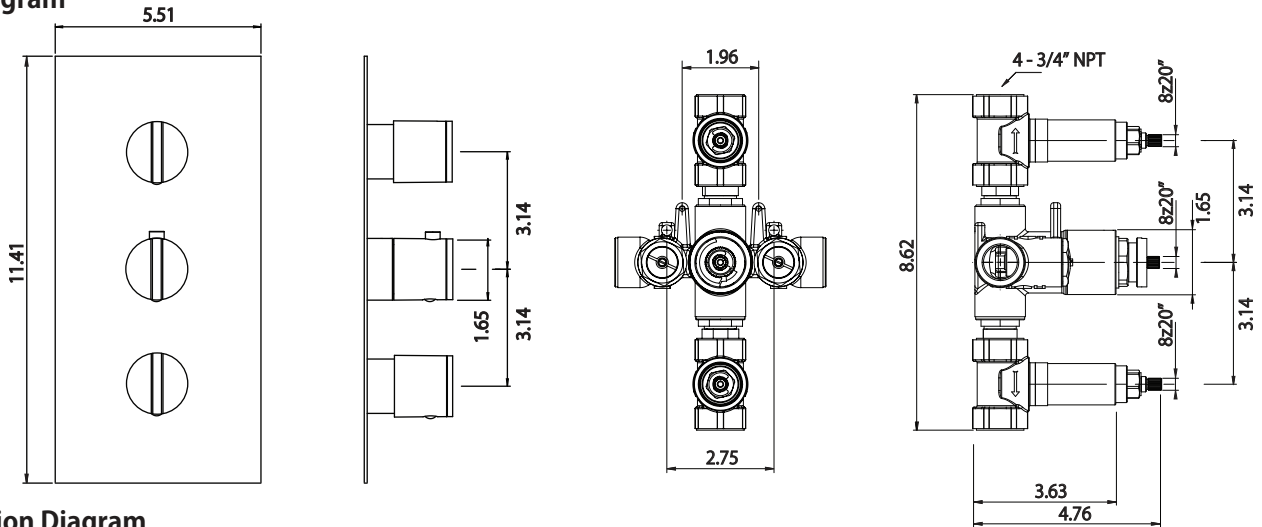

**Water Diversion Diagram**

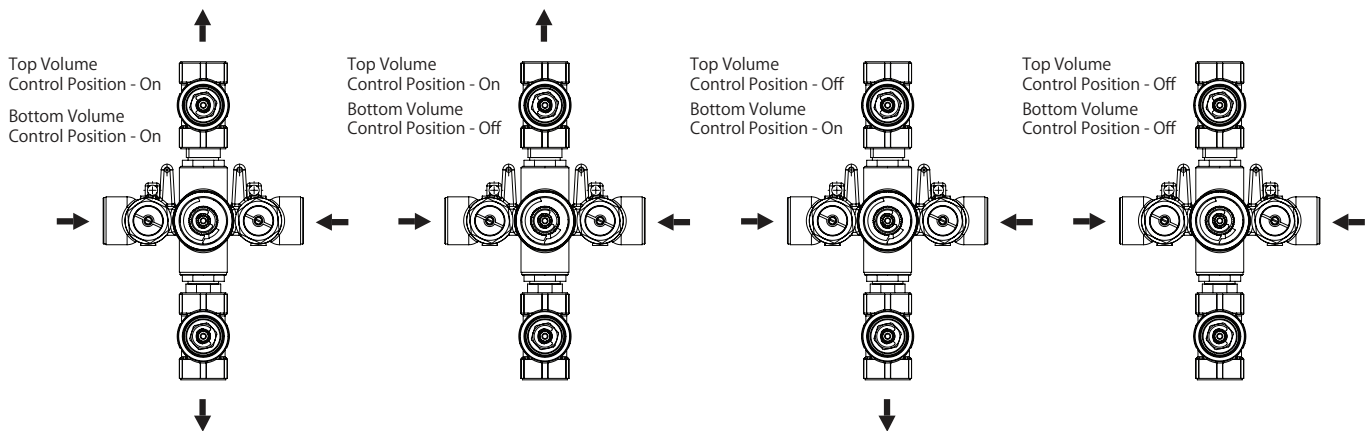

TVH.4401 | 3/4" Thermostatic Valve With 2 Independent Volume Controls Page 1 of 2



**SPECIFICATIONS:**

- Turn middle knob to control temperature.
- Turn top knob to control water flow from top output.
- Turn bottom to control water flow from bottom output.
- Thermostatic Valve Flow Rate - 13.0 GPM @ 60 PSI

**STANDARDS:**

- ASME A112.18.1 / CSA B125.1

**WARRANTY:**

- Limited lifetime warranty to the original consumer purchaser against finish and workmanship

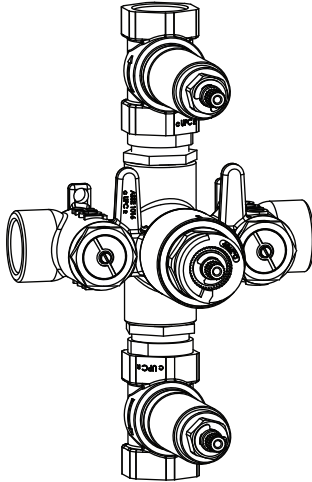

Legislation Compliance



ZeroDrip Technology



**Technical Diagram**

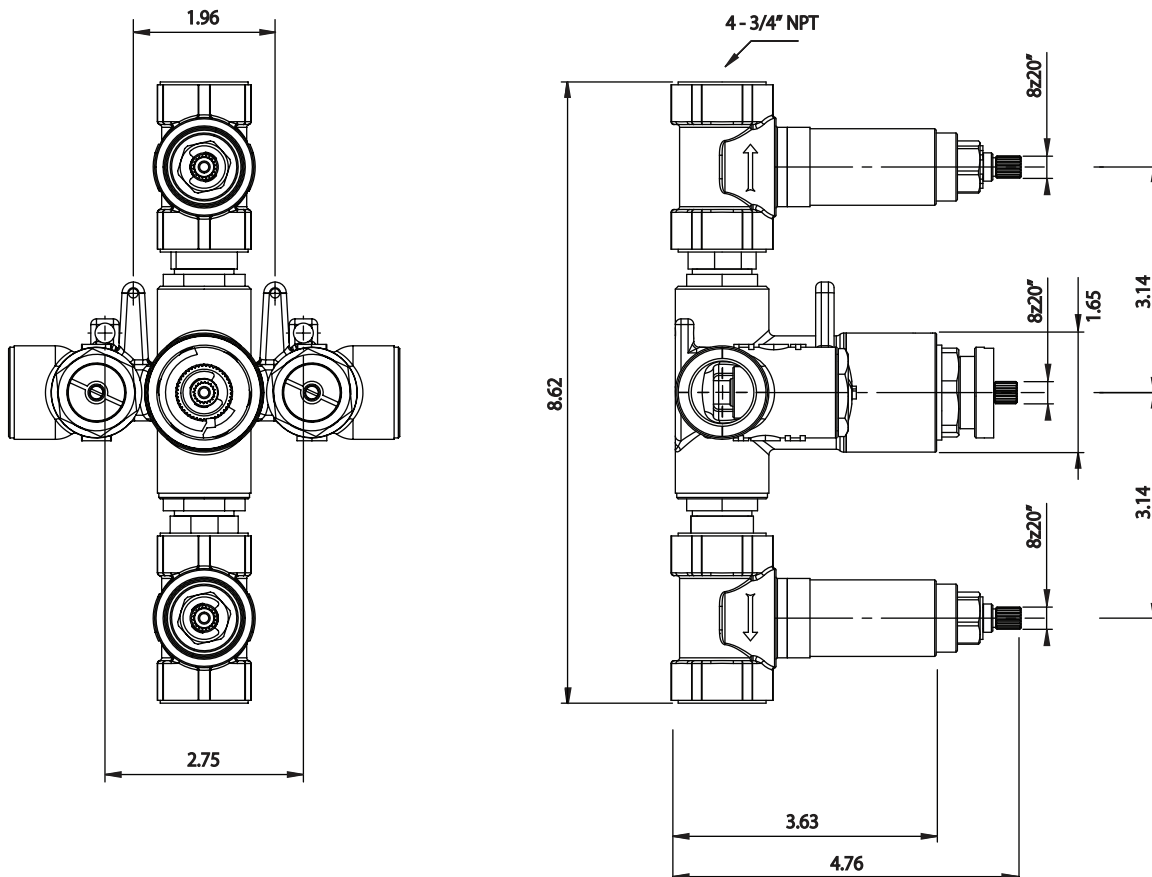

TVH.4401 | 3/4" Thermostatic Valve With 2 Independent Volume Controls Page 2 of 2



Water Flow Diagram

