

22-1.2S-TIA

Wall Mounted 2 Hole Lavatory Set

Does Not Include Drain

Requires Valve SS-SHV1.2

Flow Rate: 1.2 GPM

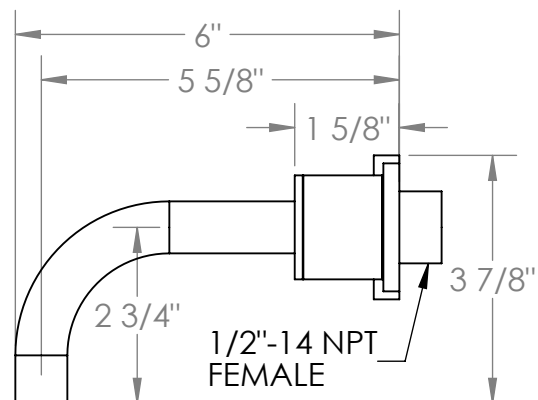
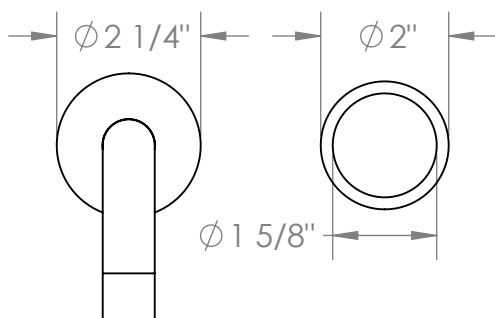

Meets the applicable requirements of ASME A112.18.1-2005/CSA B125.1-05, entitled "Plumbing Supply Fittings"

WATERMARK DESIGNS 12/13/2019

350 Dewitt Ave Brooklyn NY 11207 USA T 718 257 2800 F 718 257 2144 info@watermark-designs.com